

### DESCRIPTION

LC1117 is a series of low dropout three-terminal regulators with a dropout of 1.3V at 1A load current. LC1117 features a low standby current 2mA.

Other than a fixed version ( $V_{out} = 1.2V, 1.5V, 1.8V, 2.5V, 3.3V, 5V, \text{ and } 12V$ ), LC1117 has an adjustable version, which can provide an output voltage from 1.25 to 12V with only two external resistors.

LC1117 offers thermal shut down and current limit functions, to assure stability of chip and power system. Trimming technique is used to guarantee output voltage accuracy within  $\pm 2\%$ . Other output voltage accuracy such as  $\pm 1\%$  can be customized on demand.

LC1117 is available in SOT-223, TO-252 power packages.

### TYPICAL APPLICATION

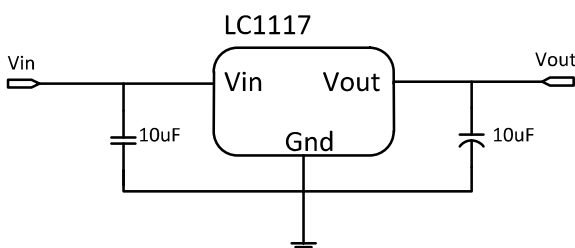

Application circuit of LC1117 fixed version

### FEATURES

- Other than a fixed version and an adjustable version, output value can be customized on demand.
- Maximum output current is 1A
- Range of operation input voltage: Max 18V
- Standby current: 2mA (typ.)
- Line regulation: 0.1%/V (typ.)
- Load regulation: 10mV (typ.)
- Environment Temperature:  $-40^{\circ}C \sim 85^{\circ}C$
- Compatible with tantalum capacitor, electrolytic capacitor and MLCC.

### APPLICATIONS

- Power Management for Computer Mother Board, Graphic Card
- LCD Monitor and LCD TV
- DVD Decode Board
- ADSL Modem
- Post Regulators for Switching Supplies

### TYPICAL ELECTRICAL CHARACTERISTIC

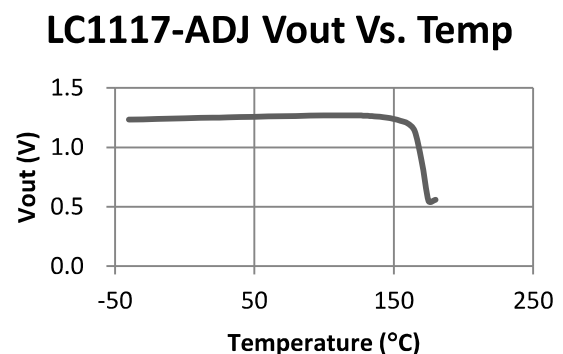

## ORDERING INFORMATION

LC1117 [1](#) [2](#) [3](#) [4](#) [5](#)

Code	Description
<a href="#">1</a>	Temperature&Rohs: C:-40~85°C ,Pb Free Rohs Std.
<a href="#">2</a>	Package type: L:SOT-223 O:TO-252
<a href="#">3</a>	Packing type: TR:Tape&Reel (Standard)
<a href="#">4</a>	Output voltage: e.g. 12=1.2V 15=1.5V 18=1.8V 25=2.5V 33=3.3V 50=5.0V 120=12V AD=Output adjustable
<a href="#">5</a>	Voltage accuracy: 1=±1%(Customized) Blank(default)=±2%

## PIN CONFIGURATION

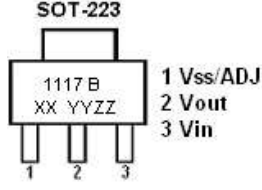
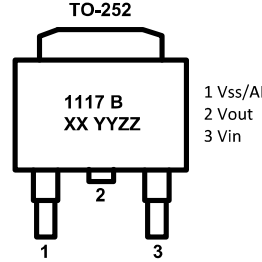
Product Classification		LC1117CLTR <a href="#">1</a> <a href="#">2</a>
Marking		
1117 B XXYYZZ	1117: Product Code	
	B: Fab Code	
	XX: Output Voltage	
	YY: Lot No.	
ZZ: Date Code		
Product Classification		LC1117COTR <a href="#">1</a> <a href="#">2</a>
1117 B XXYYZZ	1117: Product Code	
	B:Fab Code	
	XX: Output Voltage	
	YY:Lot No.	
ZZ:Date Code		
<b>Vss/Adj</b>	Ground Pin/Adjustable	
<b>Vin</b>	Supply Voltage Input	
<b>Vout</b>	Output Voltage	

## ABSOLUTE MAXIMUM RATING

Parameter		Value
Max Input Voltage		18V <sup>①</sup>
Max Operating Junction Temperature(Tj)		150°C
Ambient Temperature(Ta)		-40°C – 85°C
Package Thermal Resistance(θjc)	SOT-223	20°C / W
	TO-252	12.5°C / W
Storage Temperature(Ts)		-40°C - 150°C
Lead Temperature & Time		260°C, 10S

**Note:** Exceed these limits to damage to the device. Exposure to absolute maximum rating conditions may affect device reliability.

## RECOMMENDED WORK CONDITIONS

Parameter	Value
Input Voltage Range	Max. 16V <sup>①</sup>
Operating Junction Temperature(Tj)	-40°C –125°C

<sup>①</sup>Exceptional for LC1117-12V, the maximum input voltage for LC1117-12V is 20V.

## ELECTRICAL CHARACTERISTICS

T<sub>j</sub>=25°C

Symbol	Parameter	Conditions	Min	Typ	Max	Unit
V <sub>ref</sub>	Reference Voltage	LC1117-ADJ 10mA ≤ I <sub>out</sub> ≤ 1A, V <sub>in</sub> = 3.25V	1.225	1.25	1.275	V
V <sub>out</sub>	Output Voltage	LC1117-1.2V 0 ≤ I <sub>out</sub> ≤ 1A, V <sub>in</sub> = 3.2V	1.176	1.2	1.224	V
		LC1117-1.5V 0 ≤ I <sub>out</sub> ≤ 1A, V <sub>in</sub> = 3.5V	1.47	1.5	1.53	V
		LC1117-1.8V 0 ≤ I <sub>out</sub> ≤ 1A, V <sub>in</sub> = 3.8V	1.764	1.8	1.836	V
		LC1117-2.5V 0 ≤ I <sub>out</sub> ≤ 1A, V <sub>in</sub> = 4.5V	2.45	2.5	2.55	V
		LC1117-3.3V 0 ≤ I <sub>out</sub> ≤ 1A, V <sub>in</sub> = 5.3V	3.234	3.3	3.366	V
		LC1117-5.0V 0 ≤ I <sub>out</sub> ≤ 1A, V <sub>in</sub> = 7.0V	4.9	5	5.1	V
		LC1117-12.0V 0 ≤ I <sub>out</sub> ≤ 1A, V <sub>in</sub> = 14V	11.76	12	12.24	V
ΔV <sub>out</sub>	Line Regulation	LC1117-1.2V I <sub>out</sub> = 10mA, 2.7V ≤ V <sub>in</sub> ≤ 15V		0.1	0.2	%/V
		LC1117-ADJ I <sub>out</sub> = 10mA, 2.75V ≤ V <sub>in</sub> ≤ 16V		0.1	0.2	%/V
		LC1117-1.5V I <sub>out</sub> = 10mA, 3.0V ≤ V <sub>in</sub> ≤ 16V		0.1	0.2	%/V
		LC1117-1.8V I <sub>out</sub> = 10mA, 3.3V ≤ V <sub>in</sub> ≤ 16V		0.1	0.2	%/V
		LC1117-2.5V I <sub>out</sub> = 10mA, 4.0V ≤ V <sub>in</sub> ≤ 16V		0.1	0.2	%/V
		LC1117-3.3V I <sub>out</sub> = 10mA, 4.8V ≤ V <sub>in</sub> ≤ 16V		0.1	0.2	%/V
		LC1117-5.0V I <sub>out</sub> = 10mA, 6.5V ≤ V <sub>in</sub> ≤ 16V		0.1	0.2	%/V
		LC1117-12.0V I <sub>out</sub> = 10mA, 13.5V ≤ V <sub>in</sub> ≤ 20V		0.1	0.2	%/V
ΔV <sub>out</sub>	Load Regulation	LC1117-ADJ V <sub>in</sub> = 2.7V, 10mA ≤ I <sub>out</sub> ≤ 1A		10	30	mV
		LC1117-ADJ V <sub>in</sub> = 2.75V, 10mA ≤ I <sub>out</sub> ≤ 1A		10	30	mV
		LC1117-1.5V V <sub>in</sub> = 3.0V, 10mA ≤ I <sub>out</sub> ≤ 1A		10	30	mV
		LC1117-1.8V V <sub>in</sub> = 3.3V, 10mA ≤ I <sub>out</sub> ≤ 1A		10	30	mV
		LC1117-2.5V V <sub>in</sub> = 4.0V, 10mA ≤ I <sub>out</sub> ≤ 1A		10	30	mV
		LC1117-3.3V V <sub>in</sub> = 4.8V, 10mA ≤ I <sub>out</sub> ≤ 1A		10	30	mV
		LC1117-5.0V V <sub>in</sub> = 6.5V, 10mA ≤ I <sub>out</sub> ≤ 1A		10	30	mV
		LC1117-12.0V V <sub>in</sub> = 13.5V, 10mA ≤ I <sub>out</sub> ≤ 1A		10	30	mV

## ELECTRICAL CHARACTERISTICS continued

T<sub>j</sub>=25°C

Symbol	Parameter	Conditions	Min	Typ	Max	Unit
V <sub>drop</sub>	Dropout Voltage	I <sub>out</sub> =100mA		1.23	1.3	V
		I <sub>out</sub> =1A		1.3	1.5	V
I <sub>limit</sub>	Current Limit	V <sub>in</sub> -V <sub>out</sub> =2V, T <sub>j</sub> =25°C	1			A
I <sub>min</sub>	Minimum Load Current	LC1117-ADJ		2	10	mA
I <sub>q</sub>	Quiescent Current	LC1117-1.2V, V <sub>in</sub> =10V		2	5	mA
		LC1117-1.5V, V <sub>in</sub> =12V		2	5	mA
		LC1117-1.8V, V <sub>in</sub> =12V		2	5	mA
		LC1117-2.5V, V <sub>in</sub> =12V		2	5	mA
		LC1117-3.3V, V <sub>in</sub> =12V		2	5	mA
		LC1117-5.0V, V <sub>in</sub> =12V		2	5	mA
		LC1117-12.0V, V <sub>in</sub> =20V		2	5	mA
I <sub>Adj</sub>	Adjust Pin Current	LC1117-ADJ V <sub>in</sub> =5V, 10mA ≤ I <sub>out</sub> ≤ 1A		55	120	uA
I <sub>change</sub>	I <sub>adj</sub> change	LC1117-ADJ V <sub>in</sub> =5V, 10mA ≤ I <sub>out</sub> ≤ 1A		0.2	10	uA
ΔV/ΔT	Temperature coefficient			±100		ppm
θ <sub>JC</sub>	Thermal Resistance	SOT-223		20		°C/W
		TO-252		10		
		TO-220		4.5		

**Note1:** All test are conducted under ambient temperature 25°C and within a short period of time 20ms

**Note2:** Load current smaller than minimum load current of LC1117-ADJ will lead to unstable or oscillation output.

## BLOCK DIAGRAM

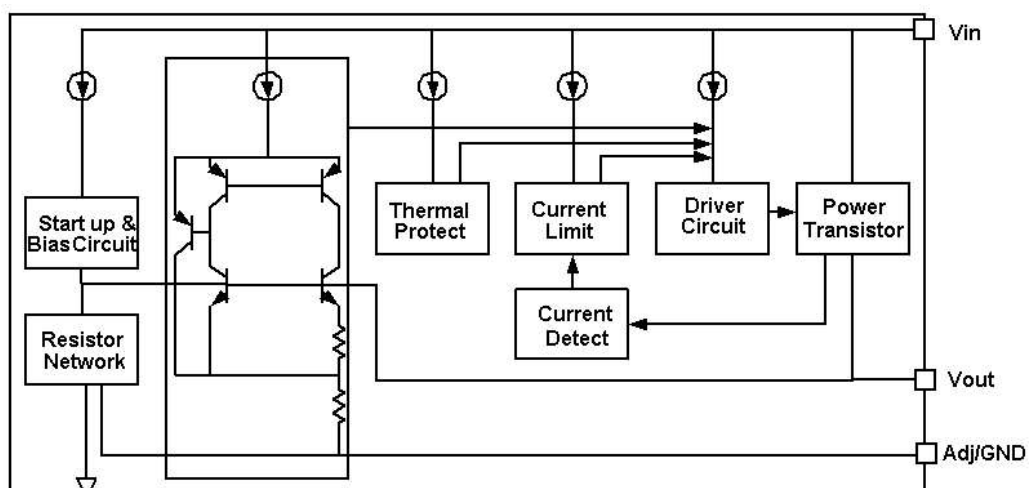

## DETAILED DESCRIPTION

LC1117 is a series of low dropout voltage, three terminal regulators. Its application circuit is very simple: the fixed version only needs two capacitors and the adjustable version only needs two resistors and two capacitors to work. It is composed of some modules including start-up circuit, bias circuit, bandgap, thermal shutdown, current limit, power transistors and its driver circuit and so on.

The thermal shut down modules can assure chip and its application system working safety when the junction temperature is larger than 140°C.

The bandgap module provides stable reference voltage, whose temperature coefficient is compensated by careful design considerations. The temperature coefficient is under 100 ppm/°C. And the accuracy of output voltage is guaranteed by trimming technique.

## TYPICAL APPLICATION

LC1117 has an adjustable version and six fixed versions (1.2V, 1.5V, 1.8V, 2.5V, 3.3V, 5V and 12V)

### Fixed Output Voltage Version

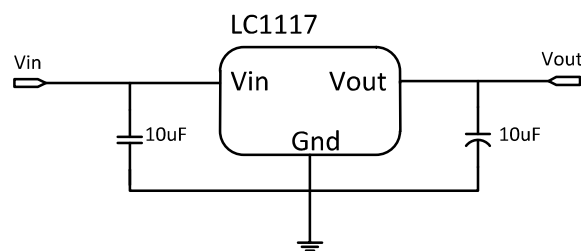

Application circuit of LC1117 fixed version

- 1) Recommend using 10uF tan capacitor as bypass capacitor (C1) for all application circuit.
- 2) Recommend using 10uF tan capacitor to assure circuit stability.

### Adjustable Output Voltage Version

LC1117-ADJ provides a 1.25V reference voltage. Any output voltage between 1.25V~12V can be achievable by choosing two external resistors (schematic is shown below), R1 and R2

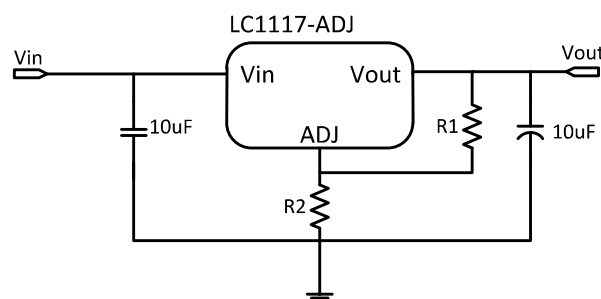

Application Circuit of LC1117-ADJ

The output voltage of adjustable version follows the equation:  $V_{out} = 1.25 \times (1 + R2/R1) + I_{Adj} \times R2$ . We can ignore  $I_{Adj}$  because  $I_{Adj}$  (about 50uA) is much less than the current of R1 (about 2~10mA).

- 1) To meet the minimum load current (>10mA) requirement, R1 is recommended to be 125ohm or lower. As LC1117-ADJ can keep itself stable at load current about 2mA, R1 is not allowed to be higher than 625ohm.
- 2) Using a bypass capacitor ( $C_{ADJ}$ ) between the ADJ pin and ground can improve ripple rejection. This bypass capacitor prevents ripple from being amplified as the output voltage is increased. The impedance of  $C_{ADJ}$  should be less than R1 to prevent ripple from being amplified. As R1 is normally in the range of  $100\Omega \sim 500\Omega$ , the value of  $C_{ADJ}$  should satisfy this equation:  $1/(2\pi \times f_{ripple} \times C_{ADJ}) < R1$ .

## THERMAL CONSIDERATIONS

We have to take heat dissipation into great consideration when output current or differential voltage of input and output voltage is large. Because in such cases, the power dissipation consumed by LC1117 is very large. LC1117 series uses SOT-223 package type and its thermal resistance is about  $20^{\circ}\text{C}/\text{W}$ . And the copper area of application board can affect the total thermal resistance. If copper area is  $5\text{cm} \times 5\text{cm}$  (two sides), the resistance is about  $30^{\circ}\text{C}/\text{W}$ . So the total thermal resistance is about  $20^{\circ}\text{C}/\text{W} + 30^{\circ}\text{C}/\text{W}$ . We can decrease total thermal resistance by increasing copper area in application board. When there is no good heat dissipation copper are in PCB, the total thermal resistance will be as high as  $120^{\circ}\text{C}/\text{W}$ , then the power dissipation of LC1117 could allow on itself is less than 1W. And furthermore, LC1117 will work at junction temperature higher than  $125^{\circ}\text{C}$  under such condition and no lifetime is guaranteed.

## TYPICAL PERFORMANCE CHARACTERISTICS

$T=25^{\circ}\text{C}$  unless specified.

### Line Regulation

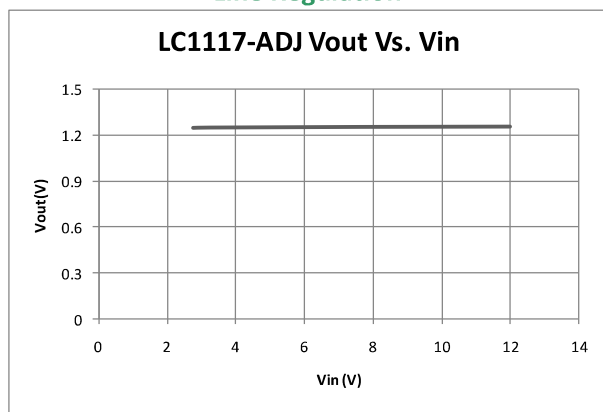

### Load Regulation

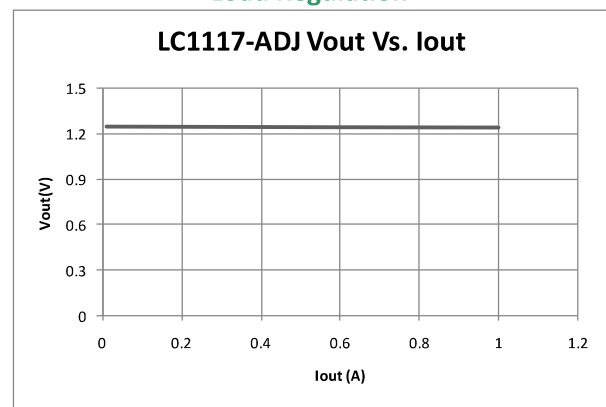

### Dropout Voltage

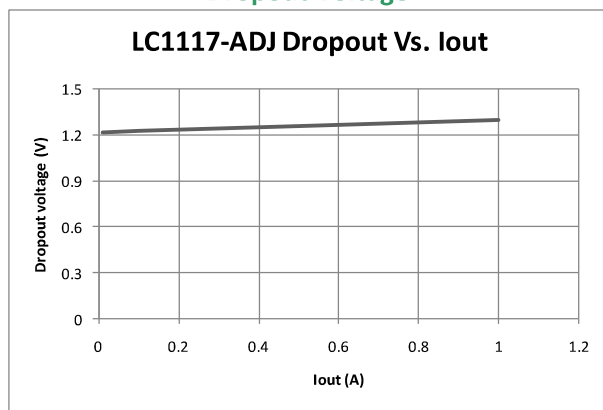

### Thermal performance with OTP

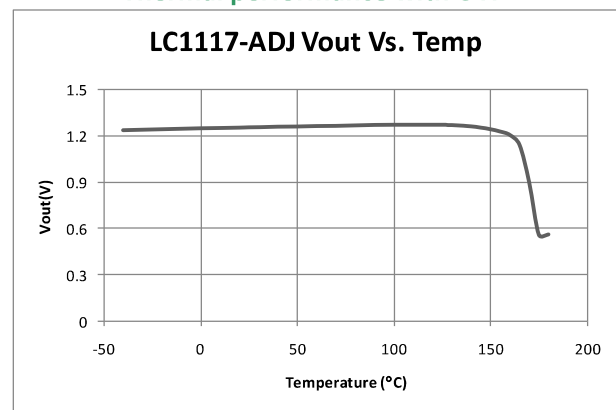

## PACKAGE OUTLINE

Package	SOT-223	Devices per reel	2500	Unit	mm
---------	---------	------------------	------	------	----

Package specification:

COMMON DIMENSIONS  
(UNITS OF MEASURE=MILLIMETER)

SYMBOL	MIN	NOM	MAX
A	-	-	1.80
A1	0.02	-	0.10
A2	1.50	1.60	1.70
A3	0.80	0.90	1.00
b	0.67	-	0.80
b1	0.66	0.71	0.76
b2	2.96	-	3.09
b3	2.95	3.00	3.05
c	0.30	-	0.35
c1	0.29	0.30	0.31
D	6.48	6.53	6.58
D1	6.55	6.60	6.65
D2	-	-	7.05
E	6.80	-	7.20
E1	3.40	3.50	3.60
E2	3.33	3.43	3.53
e	2.30BSC		
e1	4.60BSC		
L	0.80	1.00	1.20
L1	1.75REF		
L2	0.25BSC		
R	0.10	-	-
R1	0.10	-	-
θ	0°	-	8°
θ1	10°	12°	14°

NOTES:  
ALL DIMENSIONS REFER TO JEDEC STANDARD TO261-AA

Package	TO-252	Devices per reel	2500	Unit	mm
---------	--------	------------------	------	------	----

Package specification:

SYMBOL	MILLIMETER		
	MIN	NOM	MAX
A1	0	-	0.10
A2	2.2	2.3	2.4
A3	1.02	1.067	1.12
b	0.75	-	0.84
b1	0.74	-	0.79
c	0.49	-	0.57
c1	0.48	0.508	0.52
D	6.50	6.60	6.70
D1	5.334REF		
D2	4.70	4.826	4.92
E	9.90	10.10	10.30
E1	6.00	6.10	6.20
E2	5.30REF		
e	2.286BSC		
L	1.40	1.50	1.60
L2	0.90	-	1.25
L3	0.60	0.80	1.00
L4	1.70	1.80	1.90
θ	0	-	8°
L/F载体尺寸	198×133		